

FEATURES

- | | | |
|--|-------------------|---------------|
| 1). Interdigitated amplifying gates | $I_{T(AV)}$ | 897A |
| 2). Fast turn-on and high di/dt | V_{DRM}/V_{RRM} | 800~1400V |
| 3). Low switching losses | t_q | 20~28 μ s |
| 4). Short turn-off time | I_{TSM} | 12KA |
| 5). Hermetic metal cases with ceramic insulators | | |

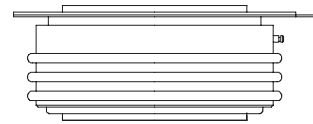

TYPICAL APPLICATIONS

- | | |
|-------------------------------|--|
| 1). Inductive heating | 4). AC motor speed control |
| 2). Electronic welders | 5). General power switching applications |
| 3). Self-commutated inverters | |

THE MAIN PARAMETERS

SYMBOL	CHARACTERISTIC	TEST CONDITIONS	$T_j(^{\circ}C)$	VALUE			UNIT
				Min	Type	Max	
$I_{T(AV)}$	Mean forward current	180° half sine wave 50Hz Double side cooled, $T_{hs}=55^{\circ}C$	125			897	A
V_{DRM} V_{RRM}	Repetitive peak off-state voltage Repetitive peak reverse voltage	$V_{DRM} \& V_{RRM}, t_p=10ms$ $V_{DSM} \& V_{RSM} = V_{DRM} \& V_{RRM} + 100V$	125	1200		1400	V
I_{DRM} I_{RRM}	Repetitive peak off-state current Repetitive peak reverse current	$V_D = V_{DRM}$ $V_R = V_{RRM}$	125			60	mA
I_{TSM}	Surge on-state current	10ms half sine wave	125			12	KA
I^2t	I^2T for fusing coordination	$V_R = 0.6V_{RRM}$				720	$A^2s \cdot 10^3$
V_{TO}	Threshold voltage		125			1.61	V
r_T	On-state slop resistance					0.45	$m\Omega$
V_{TM}	Peak on-state voltage	$I_{TM}=1800A, F=21KN$	125			2.42	V
dv/dt	Critical rate of rise of off-state voltage	$V_{DM}=0.67V_{DRM}$	125			200	$V/\mu s$
di/dt	Critical rate of rise of on-state current	$V_{DM} = 67\%V_{DRM}$ to 1600A, Gate pulse $t_r \leq 0.5 \mu s, I_{GM}=1.5A$	125			1500	$A/\mu s$
I_m	Reverse recovery current	$I_{TM}=800A, t_p=1000 \mu s,$ $di/dt=-20A/\mu s,$ $VR=50V$	125		55		A
t_{rr}	Reverse recovery time				3.0		μs
Q_{rr}	Recovery charge				83	100	μC
tq	Circuit commutated turn-off time	$I_{TM}=800A, t_p=1000 \mu s, V_R=50V$ $dv/dt=30V/\mu s, di/dt=-20A/\mu s$	125	20		28	μs
I_{GT}	Gate trigger current			30		250	mA
V_{GT}	Gate trigger voltage	$V_A=12V, I_A=1A$	25	0.8		3.0	V
I_H	Holding current			20		400	mA
V_{GD}	Non-trigger gate voltage	$V_{DM}=67\%V_{DRM}$	125	0.3			V
$R_{th(j-h)}$	Thermal resistance Junction to heatsink	At 180° sine, double side cooled Clamping force 21KN				0.030	$^{\circ}C /W$
F_m	Mounting force			18		25	KN
T_{stg}	Stored temperature			-40		140	$^{\circ}C$
W_t	Weight				400		g
Size	Package box size						mm

PERFORMANCE CURVES FIGURE

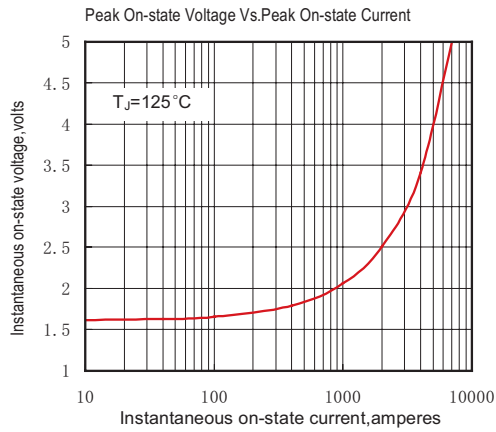

Fig.1

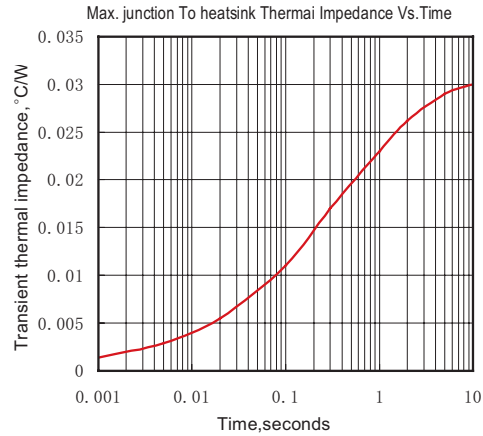

Fig.2

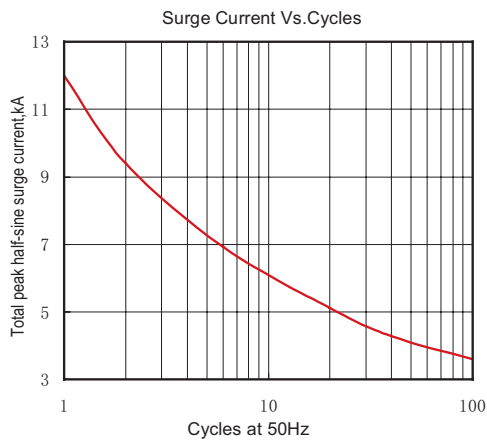

Fig.3

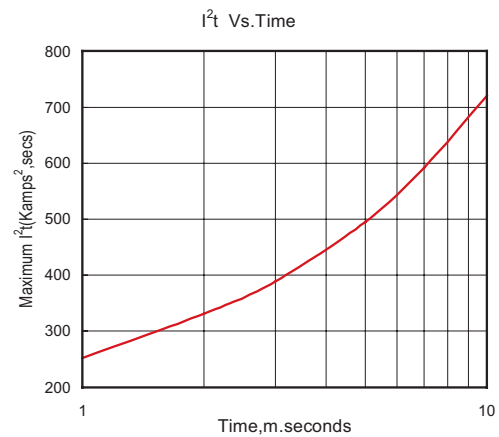

Fig.4

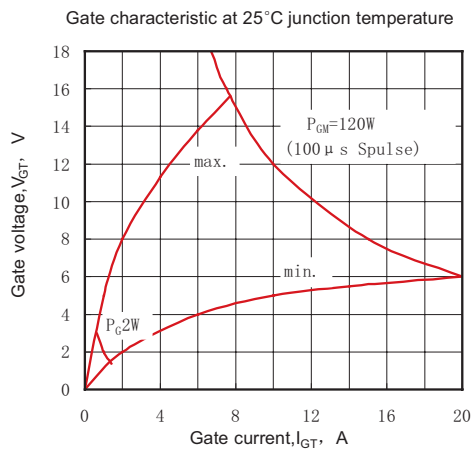

Fig.5

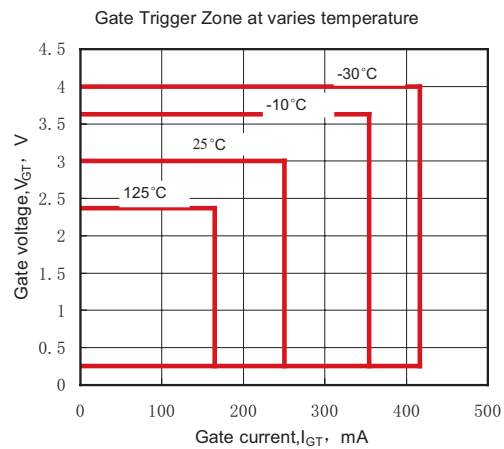
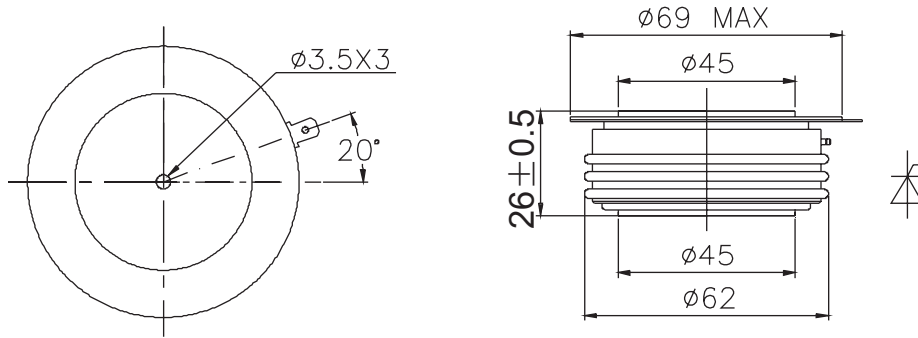

Fig.6

OUTLINE



YUEQING LIUJING RECTIFIER CO., LTD

Sale Department: Liujing Building, Yueqing City,
Zhejiang Province

Add: Wanao Industrial Zone, Yueqing city,
Zhejiang Province

Tel: 0086-577-62519692 0089-577-62519693

Fax: 0086-577-62518692

International Export: 0086-577-62571902

Technical Support: 0086-15868768965

After Service: 400-6606-086

<http://www.china-liujing.com>

<http://www.liujingdianqi.cn>

<http://www.cnrectifier.com>

<http://www.cnthyristor.com.cn>

MSN: thristors@hotmail.com

打造最具竞争力的电力半导体产品

To be the most competitive Power Semiconductor
Devices manufactory.

LIUJING reserves the right to change limits, test conditions and dimensions.

윤정은 이 칼타로그 중에 데이트, 테스트 조건, 외형사이즈에 대한 최종 해석권을 가지고 있습니다.