

FEATURES

- 1). Low forward voltage drop
- 2). High reverse voltage
- 3). Hermetic metal cases with ceramic insulators

TYPICAL APPLICATIONS

- 1). All purpose high power rectifier diodes
- 2). High power resistance welding equipment
- 3). Non-controllable and half-controllable rectifiers
- 4). Controlled rectifiers

$I_{F(AV)}$	1620 A
V_{RRM}	200~1000 V
I_{FSM}	15 KA
I^2t	$1125 \cdot 10^3 A^2S$

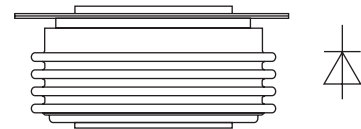

THE MAIN PARAMETERS

SYMBOL	CHARACTERISTIC	TEST CONDITIONS	$T_j(^{\circ}C)$	VALUE			UNIT
				Min	Type	Max	
$I_{F(AV)}$	Mean forward current	180° half sine wave 50Hz Double side cooled, $T_{hs}=55^{\circ}C$ $T_{hs}=145^{\circ}C$	175			1620 600	A
V_{RRM}	Repetitive peak reverse voltage	V_{RRM} tp=10ms, $V_{RSM}=V_{RRM}+100V$	175	200		1000	V
I_{RRM}	Repetitive peak current	$V_{RM}=V_{RRM}$	175			40	mA
I_{FSM}	Surge on-state current	10ms half sine wave, $V_R=0.6V_{RRM}$	175			15	KA
I^2t	I^2T for fusing coordination					1125	$A^2s \cdot 10^3$
V_{FO}	Threshold voltage		175			1.05	V
r_F	Forward slop resistance					0.30	mΩ
V_{FM}	Peak on-state voltage	$I_{TM}=1800A, F=15KN$	175			1.59	V
I_{rm}	Reverse recovery current	$I_{TM}=1000A, tp=1000 \mu s, di/dt=-20A/\mu s, V_R=50V$	175			90	A
t_{rr}	Reverse recovery time					4.2	μs
Q_{rr}	Recovery charge					189	μC
$R_{th(j-h)}$	Thermal resistance Junction to heatsink	At 180° sine, double side cooled Clamping force 15.0KN				0.033	°C /W
F_m	Mounting force			10		20	KN
T_{stg}	Stored temperature			-40		190	°C
W_t	Weight				260		g
Size	Package box size					95 × 95 × 50	mm

PERFORMANCE CURVES FIGURE

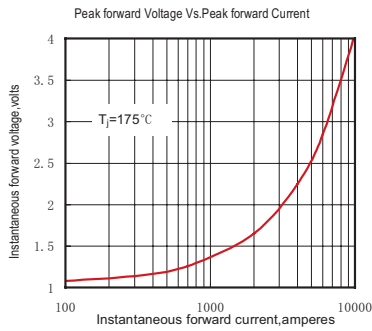

Fig.1

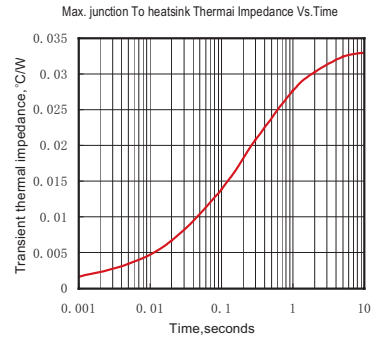

Fig.2

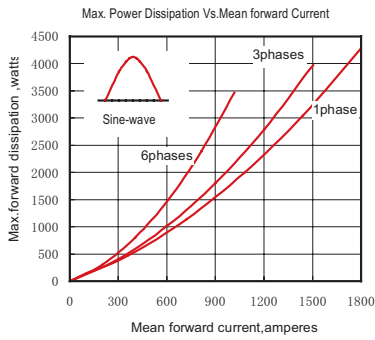

Fig.3

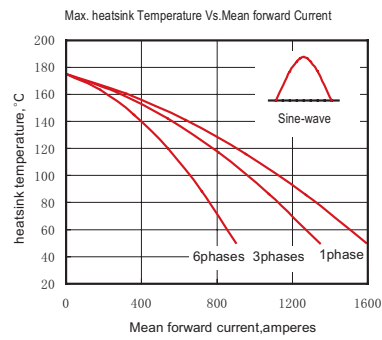

Fig.4

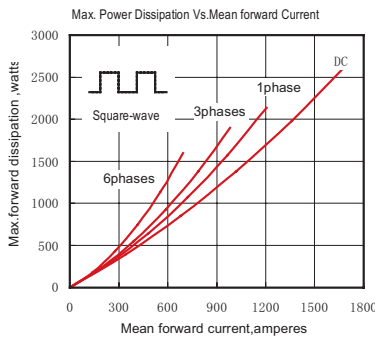

Fig.5

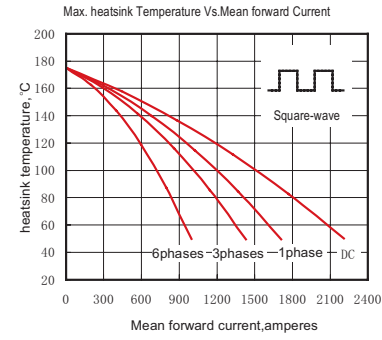

Fig.6

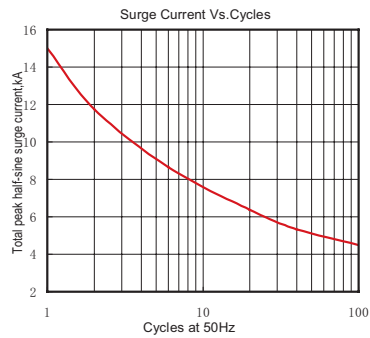

Fig.7

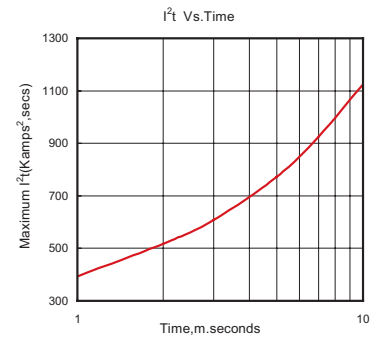
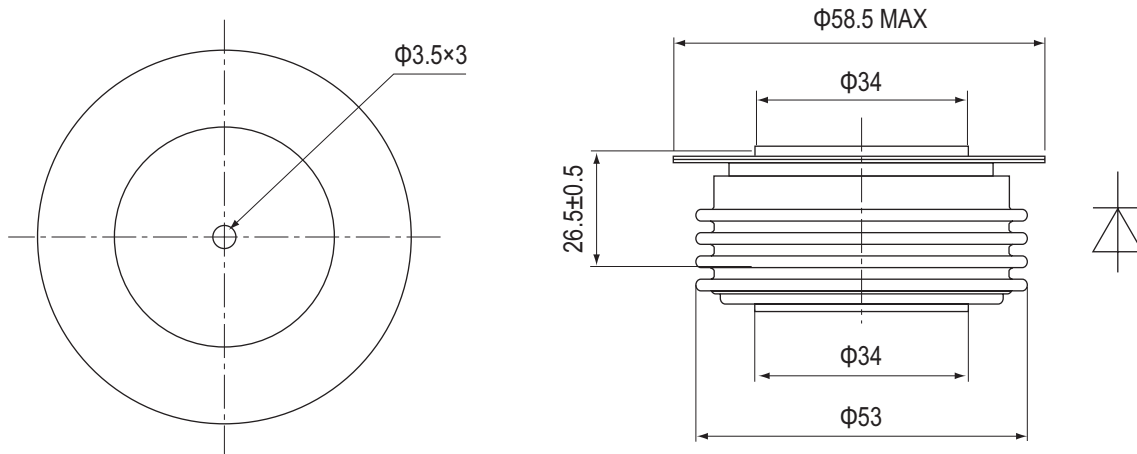

Fig.8

OUTLINE



YUEQING LIUJING RECTIFIER CO., LTD

Sale Department: Liuqing Building, Yueqing City,
Zhejiang Province

Add: Wanao Industrial Zone, Yueqing city,
Zhejiang Province

Tel: 0086-577-62519692 0089-577-62519693

Fax: 0086-577-62518692

International Export: 0086-577-62571902

Technical Support: 0086-15868768965

After Service: 400-6606-086

<http://www.china-liujing.com>

<http://www.liujingdianqi.cn>

<http://www.cnrectifier.com>

<http://www.cnthyristor.com.cn>

MSN: thristors@hotmail.com

打造最具竞争力的电力半导体产品

To be the most competitive Power Semiconductor
Devices manufactory.

LIUJING reserves the right to change limits, test conditions and dimensions.

윤정은 이 칼타로그 중에 데이트, 테스트 조건, 외형사이즈에 대한 최종 해석권을 가지고 있습니다.